

## Technical Data Sheet Top Views LEDs

### 67-22/R6G6C-B09/2T

#### Features

- P-LCC-4 package.
- White package.
- Optical indicator.
- Colorless clear window.
- Ideal for backlight and light pipe application.
- Inter reflector.
- Wide viewing angle.
- Suitable for vapor-phase reflow.
- Computable with automatic placement equipment.
- Available on tape and reel (8mm Tape).
- Pb-free.
- The product itself will remain within RoHS compliant version



#### Descriptions

- The 67-22 series is available in soft orange, green, blue and yellow. Due to the package design, the LED has wide viewing angle and optimized light coupling by inter reflector. This feature makes ideal for light pipe application. The low current requirement makes this device ideal for portable equipment or any other application where power is at a premium.

#### Applications

- Telecommunication: indicator and backlighting in telephone and fax.
- Flat backlight for LCD's, switches and symbols.
- Light pipe application.
- General use.

#### Device Selection Guide

Chip		Emitted Color	Resin Color
Type	Material		
R6	AlGaInP	Brilliant-Red	Water Clear
G6	AlGaInP	Brilliant Yellow Green	

**Technical Data Sheet**  
**Top Views LEDs**

**67-22/R6G6C-B09/2T**

**Package Dimensions**

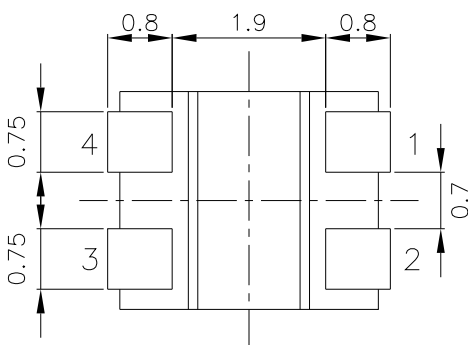
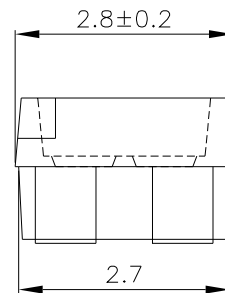
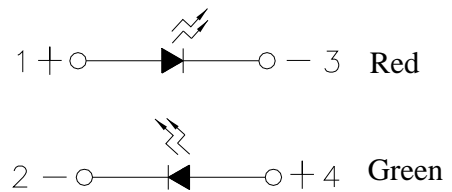
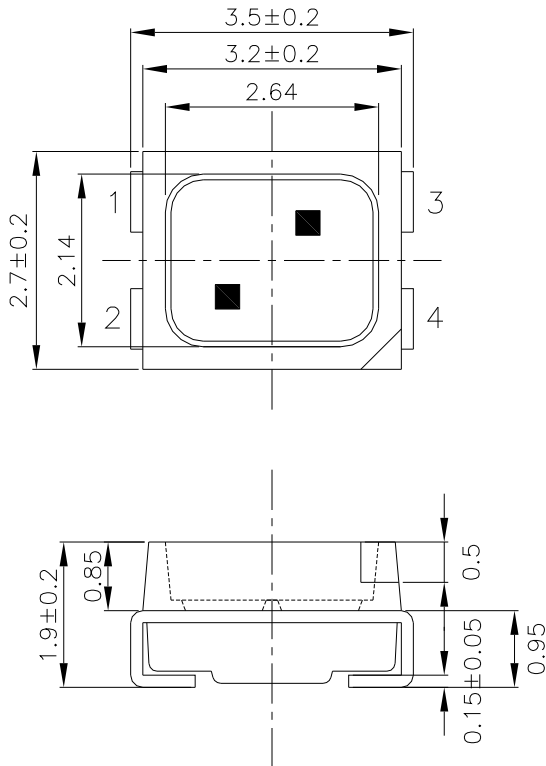

Recommended Solder Pad

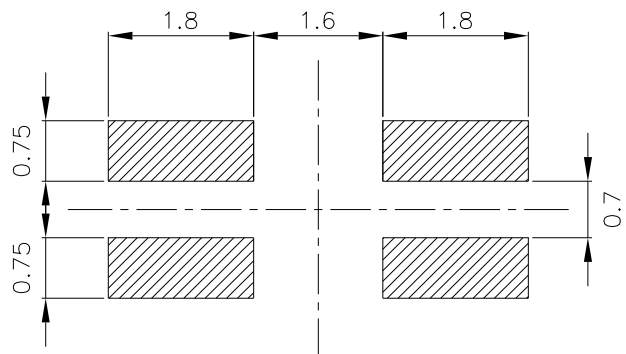

**Note:** The tolerances unless mentioned is  $\pm 0.1\text{mm}$ ; Unit = mm

**Technical Data Sheet**  
**Top Views LEDs**
**67-22/R6G6C-B09/2T**
**Absolute Maximum Ratings (Ta=25°C)**

Parameter	Symbol	Rating	Unit
Reverse Voltage	V <sub>R</sub>	5	V
Forward Current	I <sub>F</sub>	R6	25
		G6	25
Power Dissipation	Pd	R6	60
		G6	60
Peak Forward Current (Duty 1/10 @1KHz)	I <sub>FP</sub>	R6	60
		G6	60
Electrostatic Discharge(HBM)	ESD	R6	2000
		G6	2000
Operating Temperature	Topr	-40 ~ +85	°C
Storage Temperature	Tstg	-40~ +90	°C
Soldering Temperature	Tsol	Reflow Soldering : 260 °C for 10 sec. Hand Soldering : 350 °C for 3 sec.	

**Technical Data Sheet**  
**Top Views LEDs**
**67-22/R6G6C-B09/2T**
**Electro-Optical Characteristics (Ta=25°C)**

Parameter	Symbol	Min.	Typ.	Max.	Unit	Condition	
Luminous Intensity	I <sub>v</sub>	R6	57	-----	140	mcd	I <sub>F</sub> =20mA
		G6	36	-----	90	mcd	
Viewing Angle	2θ 1/2	-----	130	-----	deg	I <sub>F</sub> =20mA	
Peak Wavelength	λ <sub>p</sub>	R6	-----	632	-----	nm	I <sub>F</sub> =20mA
		G6	-----	575	-----		
Dominant Wavelength	λ <sub>d</sub>	R6	621	-----	627	nm	I <sub>F</sub> =20mA
		G6	570	-----	574		
Spectrum Radiation Bandwidth	Δλ	R6	-----	20	-----	nm	I <sub>F</sub> =20mA
		G6	-----	20	-----		
Forward Voltage	V <sub>F</sub>	R6	1.75	-----	2.35	V	I <sub>F</sub> =20mA
		G6	1.75	-----	2.35		
Reverse Current	I <sub>R</sub>	-----	-----	10	μA	V <sub>R</sub> =5V	

**Notes:**

1. Tolerance of Luminous Intensity: ±11%
2. Tolerance of Dominant Wavelength: ±1nm
3. Tolerance of Forward Voltage: ±0.1V

**Technical Data Sheet**  
**Top Views LEDs**
**67-22/R6G6C-B09/2T**
**Bin Range of Luminous Intensity**

Chip	Bin Code	Min.	Max.	Unit	Condition
R6	P2	57	72	mcd	I <sub>F</sub> =20mA
	Q1	72	90		
	Q2	90	112		
	R1	112	140		
G6	N2	36	45		
	P1	45	57		
	P2	57	72		
	Q1	72	90		

**Bin Range of Dominant Wavelength**

Chip	Bin Code	Min.	Max.	Unit	Condition
R6	0	1.75	1.95	V	I <sub>F</sub> =20mA
	1	1.95	2.15		
	2	2.15	2.35		
G6	0	1.75	1.95		
	1	1.95	2.15		
	2	2.15	2.35		

**Notes:**

1. Tolerance of Luminous Intensity:  $\pm 11\%$
2. Tolerance of Forward Voltage:  $\pm 0.1V$

**Technical Data Sheet**  
**Top Views LEDs**

**67-22/R6G6C-B09/2T**

**Typical Electro-Optical Characteristics Curves(R6)**

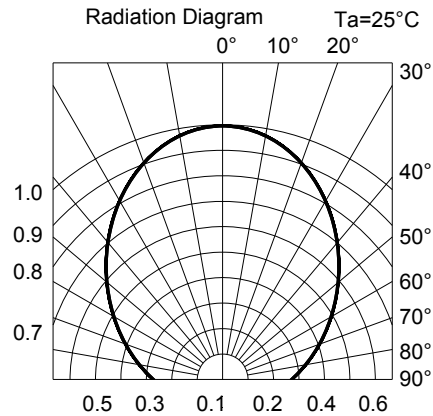
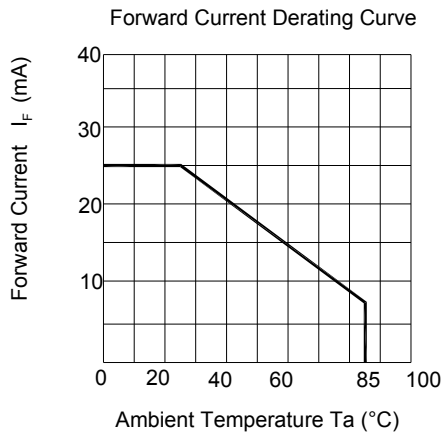
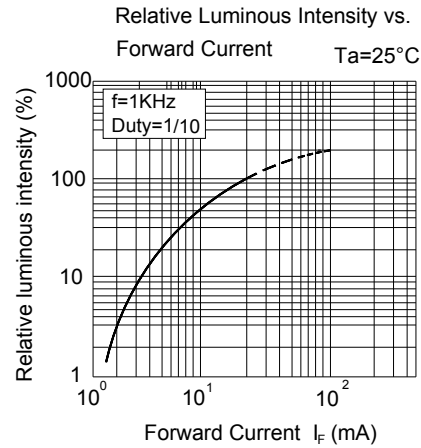
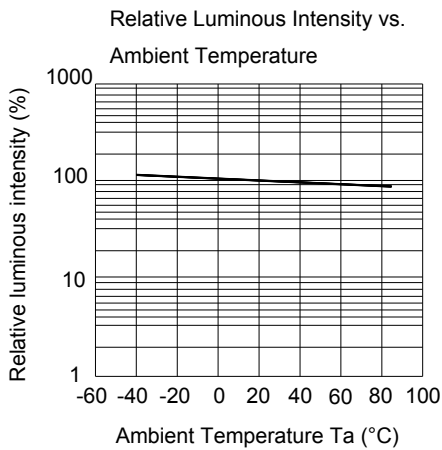
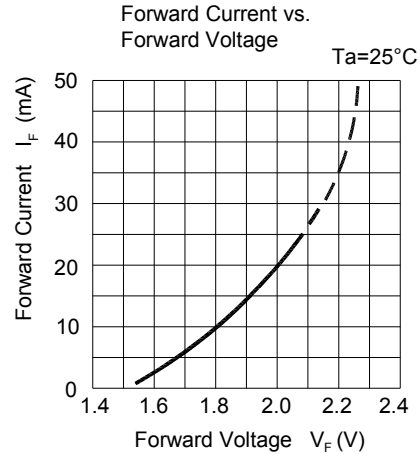
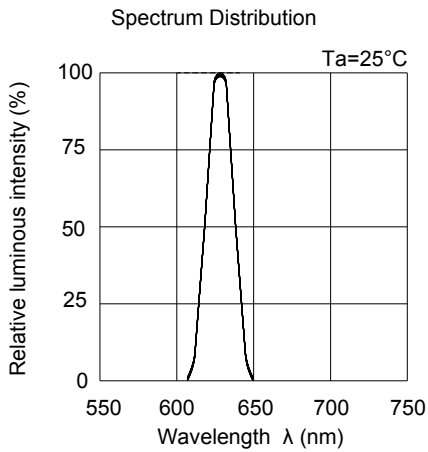

**Technical Data Sheet**  
**Top Views LEDs**

**67-22/R6G6C-B09/2T**

**Typical Electro-Optical Characteristics Curves(G6)**

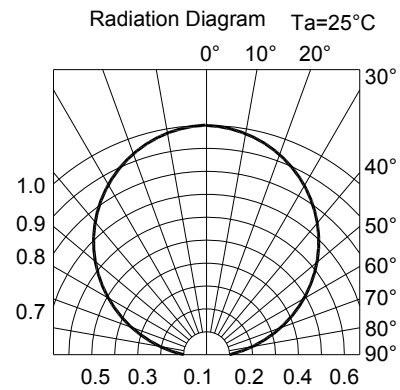
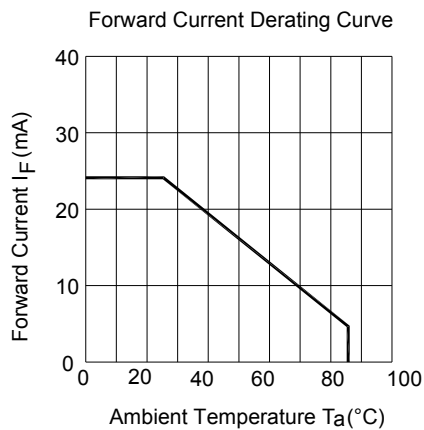
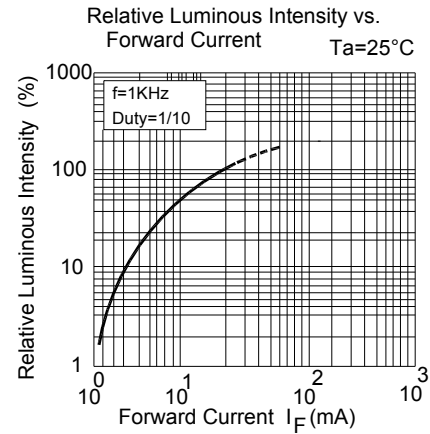
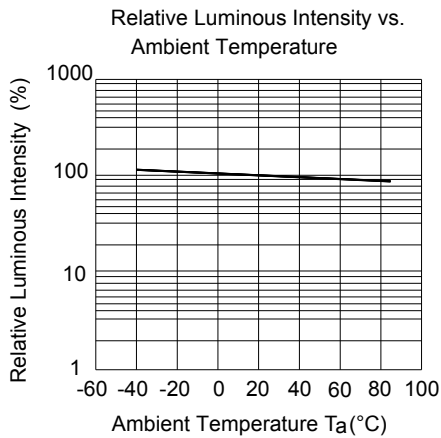
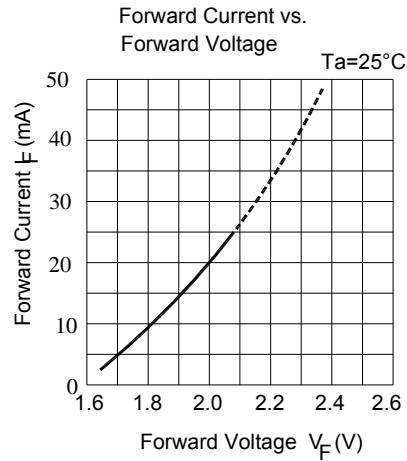
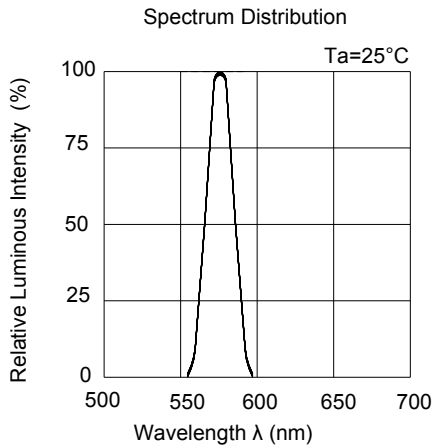

**Technical Data Sheet**  
**Top Views LEDs**

**67-22/R6G6C-B09/2T**

**Label Explanation**

CAT: Luminous Intensity Rank

HUE: Dom. Wavelength Rank

REF: Forward Voltage Rank



**Reel Dimensions**

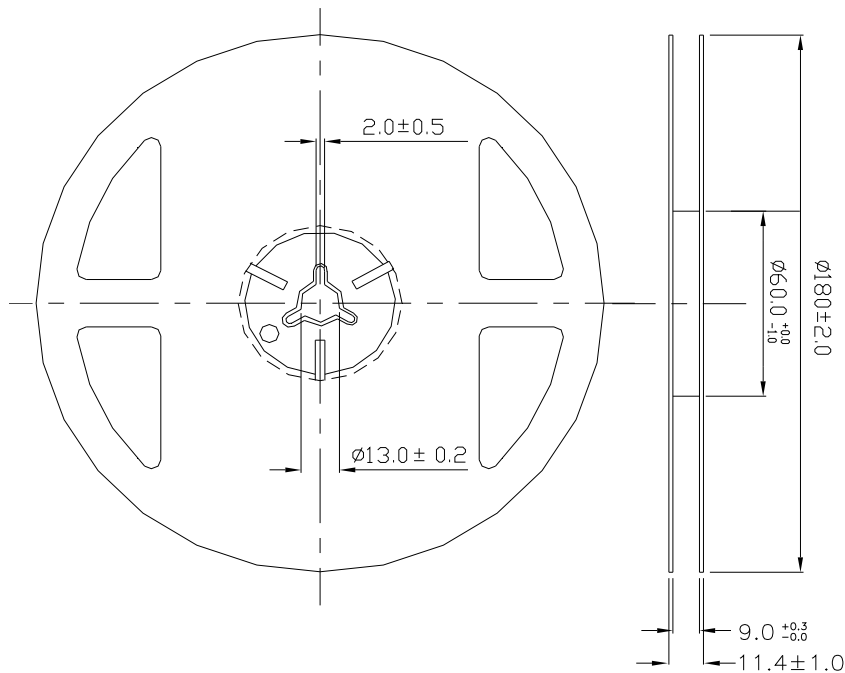

**Note:** The tolerances unless mentioned is  $\pm 0.1$ mm ,Unit = mm



**Technical Data Sheet**  
**Top Views LEDs**

**67-22/R6G6C-B09/2T**

**Carrier Tape Dimensions: Loaded Quantity 2000 PCS per reel**

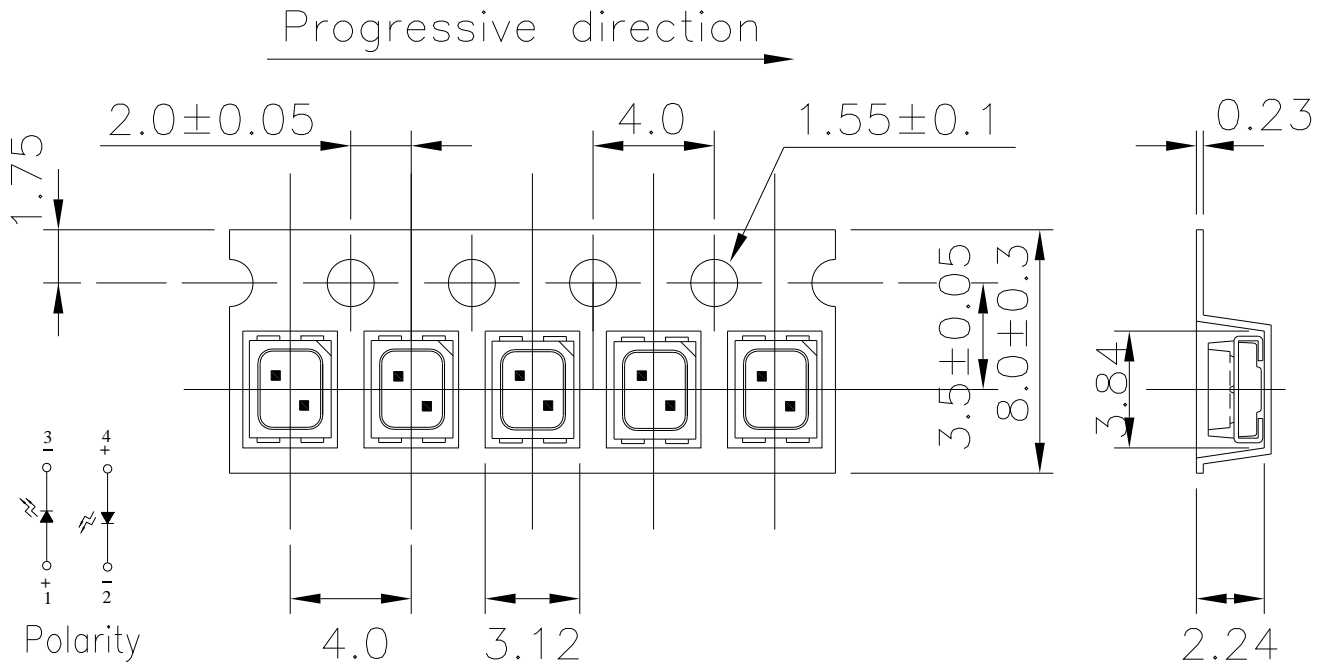

**Note:** The tolerances unless mentioned is  $\pm 0.1$ mm; Unit = mm

**Moisture Resistant Packaging**

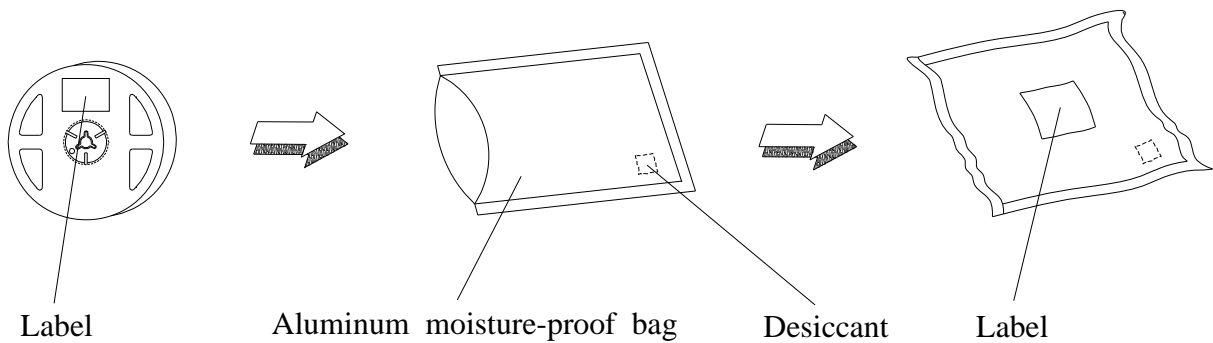

# Technical Data Sheet

## Top Views LEDs

**67-22/R6G6C-B09/2T**

### Reliability Test Items and Conditions

The reliability of products shall be satisfied with items listed below.

Confidence level : 90%

LTPD : 10%

No.	Items	Test Condition	Test Hours/Cycles	Sample Size	Ac/Re
1	Reflow Soldering	Temp. : 260°C±5°C Max. 10 sec.	6 Min.	22 PCS.	0/1
2	Temperature Cycle	H : +100°C 15min ∫ 5 min L : -40°C 15min	300 Cycles	22 PCS.	0/1
3	Thermal Shock	H : +100°C 5min ∫ 10 sec L : -10°C 5min	300 Cycles	22 PCS.	0/1
4	High Temperature Storage	Temp. : 100°C	1000 Hrs.	22 PCS.	0/1
5	Low Temperature Storage	Temp. : -40°C	1000 Hrs.	22 PCS.	0/1
6	DC Operating Life	I <sub>F</sub> = 20 mA/ 25°C	1000 Hrs.	22 PCS.	0/1
7	High Temperature / High Humidity	85°C/ 85%RH	1000 Hrs.	22 PCS.	0/1

## Technical Data Sheet

### Top Views LEDs

**67-22/R6G6C-B09/2T**

#### Precautions for Use

##### 1. Over-current-proof

Customer must apply resistors for protection , otherwise slight voltage shift will cause big current change ( Burn out will happen ).

##### 2. Storage

2.1 Do not open moisture proof bag before the products are ready to use.

2.2 Before opening the package, the LEDs should be kept at 30°C or less and 90%RH or less.

2.3 After opening the package: The LED's floor life are 168 hours under 30°C or less and 60% RH or less.

If unused LEDs remain, it should be stored in moisture proof packages.

2.4 If the moisture absorbent material (silica gel) has faded away or the LEDs have exceeded the storage time, baking treatment should be performed using the following conditions.

Baking treatment : 60±5°C for 24 hours.

##### 3. Soldering Condition

##### 3.1 Pb-free solder temperature profile

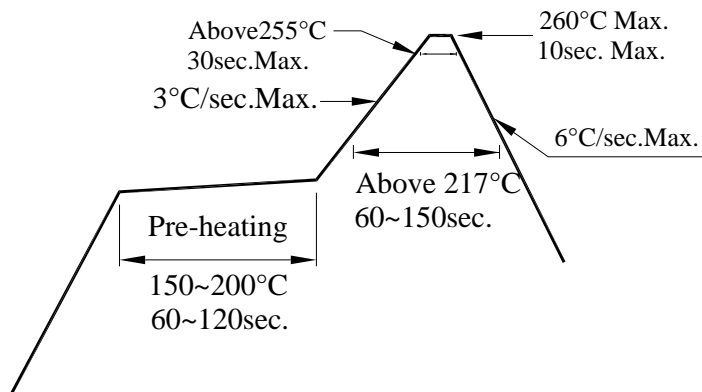

3.2 Reflow soldering should not be done more than two times.

3.3 When soldering, do not put stress on the LEDs during heating.

3.4 After soldering, do not warp the circuit board.

## Technical Data Sheet

### Top Views LEDs

**67-22/R6G6C-B09/2T**

#### 4. Soldering Iron

Each terminal is to go to the tip of soldering iron temperature less than 350°C for 3 seconds within once in less than the soldering iron capacity 25W. Leave two seconds and more intervals, and do soldering of each terminal. Be careful because the damage of the product is often started at the time of the hand solder.

#### 5. Repairing

Repair should not be done after the LEDs have been soldered. When repairing is unavoidable, a double-head soldering iron should be used (as below figure). It should be confirmed beforehand whether the characteristics of the LEDs will or will not be damaged by repairing.

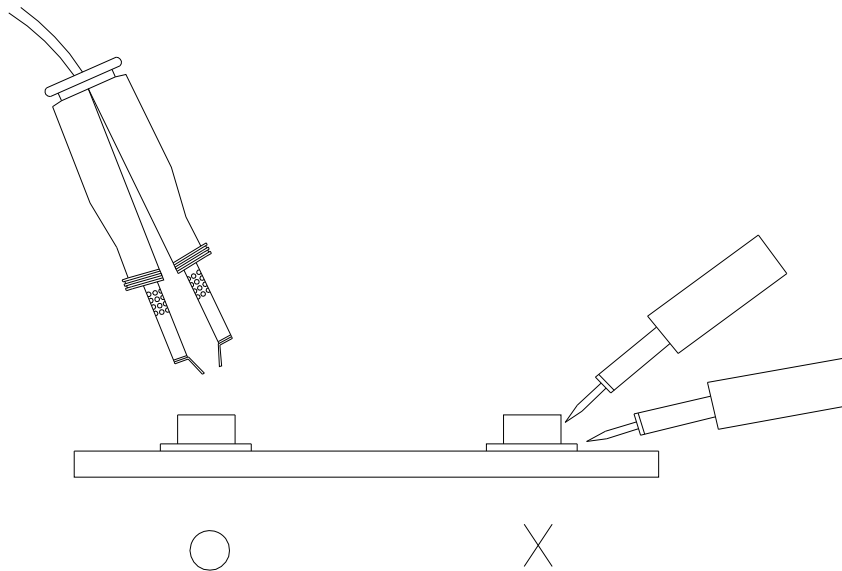

**EVERLIGHT ELECTRONICS CO., LTD.**  
Office: No 25, Lane 76, Sec 3, Chung Yang Rd,  
Tucheng, Taipei 236, Taiwan, R.O.C

Tel: 886-2-2267-2000, 2267-9936  
Fax: 886-2267-6244, 2267-6189, 2267-6306  
<http://www.everlight.com>