

Technical Data Sheet

Top View LEDs

GT3020/X2C-BXXXXXXXXXX/2T

Features

- P-LCC-2 package.
- Fluorescence Type
- High Luminous Intensity
- High Efficiency
- Pb-free.
- The product itself will remain within RoHS compliant version.

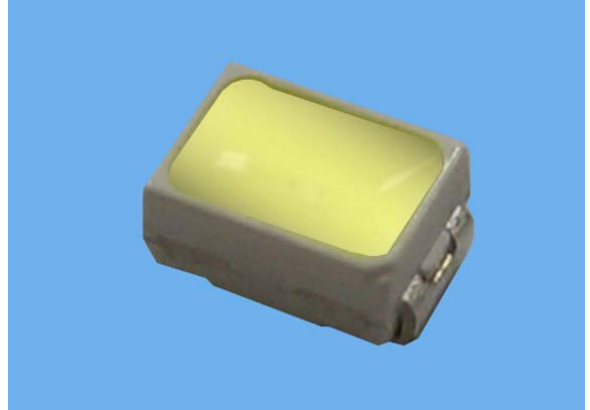

Descriptions

- Due to the package design, GT3020 has wide viewing angle, low power consumption and white LEDs are devices which are materialized by combing Blue LEDs and special phosphors. This feature makes the LED ideal for light guide application.

Applications

- General lighting
- Decorative and Entertainment Lighting.
- Indicators.
- Illuminations.
- Switch lights.

Device Selection Guide

Chip	Emitted Color	Resin Color
Material		
InGaN	Cool White Warm White	Water Clear

Technical Data Sheet

Top View LEDs

GT3020/X2C-BXXXXXXXXXX/2T

Product Number Explanation

GT3020 / X 2 C - B XX XX XX XX XX / 2T



Notes

Table of Color Rendering Index

Symbol	Description
M	CRI _(min) : 60
N	CRI _(min) : 65
L	CRI _(min) : 70
Q	CRI _(min) : 75
K	CRI _(min) : 80
H	CRI _(min) : 90

Notes:

1. Tolerance of Color Rendering Index: ±2

Example:

GT3020/Q2C-B4556AC2CB2/2T

CRI	Min=75
CCT	4500K~5650K
IV	1800mcd~2200mcd
VF	2.9V~3.6V



Technical Data Sheet

Top View LEDs

GT3020/X2C-BXXXXXXXXXX/2T

Mass Production list

Product	CRI min.	CCT(K)	I _V (mcd) Min	I _V (mcd) Max	Φ(lm) Typ.
GT3020/L2C-B5670AC2CB2/2T	70	5650K~7000K	1800	2200	6.2
GT3020/L2C-B50632C4CB2/2T	70	5000K~6300K	2000	2400	6.8
GT3020/L2C-B5063AC2CB2/2T			1800	2200	6.2
GT3020/L2C-B45562C4CB2/2T	70	4500K~5650K	2000	2400	6.8
GT3020/L2C-B4556AC2CB2/2T			1800	2200	6.2
GT3020/L2C-B2832AC2CB2/2T	70	2850K~3250K	1800	2200	6.2
GT3020/L2C-B28328BACB2/2T			1600	2000	5.6
GT3020/Q2C-B5063AC2CB2/2T	75	5000K~6300K	1800	2200	6.2
GT3020/Q2C-B50638BACB2/2T			1600	2000	5.6
GT3020/Q2C-B4556AC2CB2/2T	75	4500K~5650K	1800	2200	6.2
GT3020/Q2C-B45568BACB2/2T			1600	2000	5.6
GT3020/Q2C-B2832AC2CB2/2T	75	2850K~3250K	1800	2200	6.2
GT3020/Q2C-B28328BACB2/2T			1600	2000	5.6

Technical Data Sheet

Top View LEDs

GT3020/X2C-BXXXXXXXXXX/2T

Package Dimensions

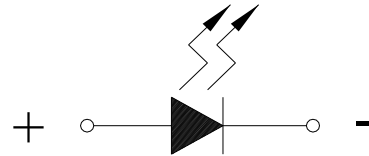
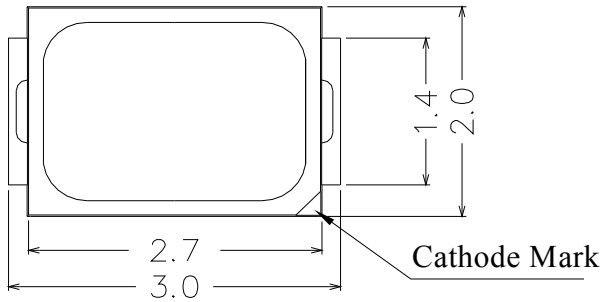

Polarity

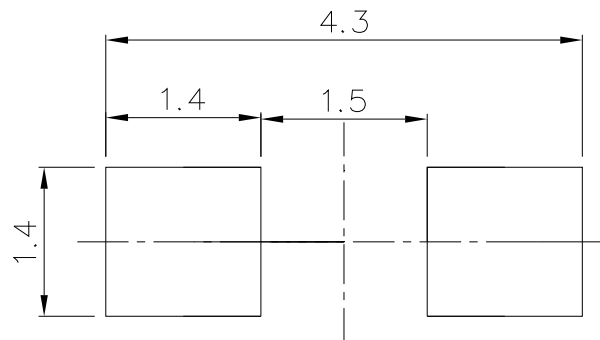
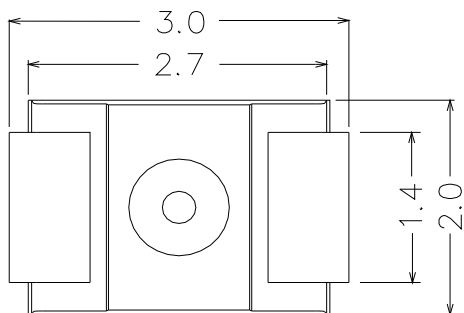
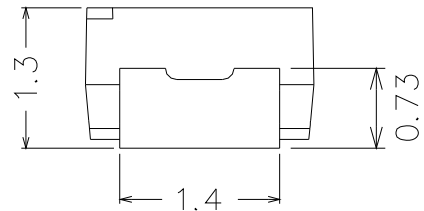
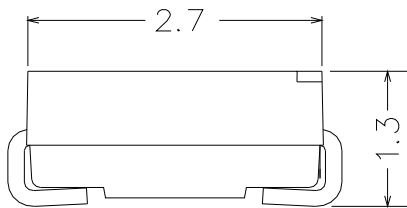

Recommended soldering pad design

Note: Tolerance unless mentioned is $\pm 0.1\text{mm}$; Unit = mm



Technical Data Sheet

Top View LEDs

GT3020/X2C-BXXXXXXXXXX/2T

Absolute Maximum Ratings (Ta=25°C)

Parameter	Symbol	Rating	Unit
Reverse Voltage	V _R	5	V
Forward Current	I _F	30	mA
Peak Forward Current (Duty 1/10 @1KHz)	I _{FP}	100	mA
Power Dissipation	P _d	110	mW
Electrostatic Discharge	ESD	1000	V
Operating Temperature	T _{opr}	-40 ~ +85	°C
Storage Temperature	T _{stg}	-40 ~ +90	°C
Soldering Temperature	T _{sol}	Reflow Soldering : 260 °C for 10 sec. Hand Soldering : 350 °C for 3 sec.	

Electro-Optical Characteristics (Ta=25°C)

Parameter	Symbol	Min.	Typ.	Max.	Unit	Condition
Viewing Angle	2θ _{1/2}	-----	120	-----	deg	I _F =20mA
Reverse Current	I _R	-----	-----	10	μA	V _R =5V



Technical Data Sheet

Top View LEDs

GT3020/X2C-BXXXXXXXXXX/2T

Bin Range of Luminous Intensity

Bin Code	Min.	Max.	Unit	Condition
4B	1200	1400	mcd	I _F =20mA
6B	1400	1600		
8B	1600	1800		
AC	1800	2000		
2C	2000	2200		
4C	2200	2400		
6C	2400	2600		
8C	2600	2800		

Bin Range of Forward Voltage

Group	Bin Code	Min.	Max.	Unit	Condition	
G	[Grey]	34	2.7	2.8	V	I _F =20mA
		35	2.8	2.9		
	B2	36	2.9	3.0		
		37	3.0	3.1		
		38	3.1	3.2		
		39	3.2	3.3		
		40	3.3	3.4		
		41	3.4	3.5		
		42	3.5	3.6		
	[Grey]	43	3.6	3.7		

Notes:

1. Tolerance of Luminous Intensity: ±11%
2. Tolerance of Forward Voltage: ±0.05V

Technical Data Sheet
Top View LEDs
GT3020/X2C-BXXXXXXXXXX/2T
Bin Range of Chromaticity Coordinates
 $I_F=20mA$

CCT	Bin Code	CIE_x	CIE_y	CCT	Bin Code	CIE_x	CIE_y
7000K ~6300K	X5	0.3031	0.3327	5000K ~4500K	U5	0.3469	0.3717
		0.3148	0.3444			0.3642	0.3829
		0.3160	0.3332			0.3622	0.3716
		0.3052	0.3224			0.3458	0.3592
	X6	0.3052	0.3224		U6	0.3458	0.3592
		0.3160	0.3332			0.3622	0.3716
		0.3175	0.3204			0.3594	0.3557
		0.3076	0.3108			0.3444	0.3442
6300K ~5650K	W5	0.3148	0.3444	3250K ~3050K	P5	0.4312	0.4234
		0.3288	0.3569			0.4456	0.4287
		0.3290	0.3451			0.4376	0.4116
		0.3160	0.3332			0.4240	0.4065
	W6	0.3160	0.3332		P6	0.4240	0.4065
		0.3290	0.3451			0.4376	0.4116
		0.3292	0.3313			0.4294	0.3943
		0.3175	0.3204			0.4165	0.3890
5650K ~5000K	V5	0.3288	0.3569	3050K ~2850K	N5	0.4456	0.4287
		0.3469	0.3717			0.4614	0.4333
		0.3458	0.3592			0.4525	0.4162
		0.3290	0.3451			0.4376	0.4116
	V6	0.3290	0.3451		N6	0.4376	0.4116
		0.3458	0.3592			0.4525	0.4162
		0.3444	0.3442			0.4436	0.3991
		0.3292	0.3313			0.4294	0.3943

Note: Tolerance of Chromaticity Coordinates: ± 0.01

Technical Data Sheet

Top View LEDs

GT3020/X2C-BXXXXXXXXXX/2T

The C.I.E. 1931 Chromaticity Diagram

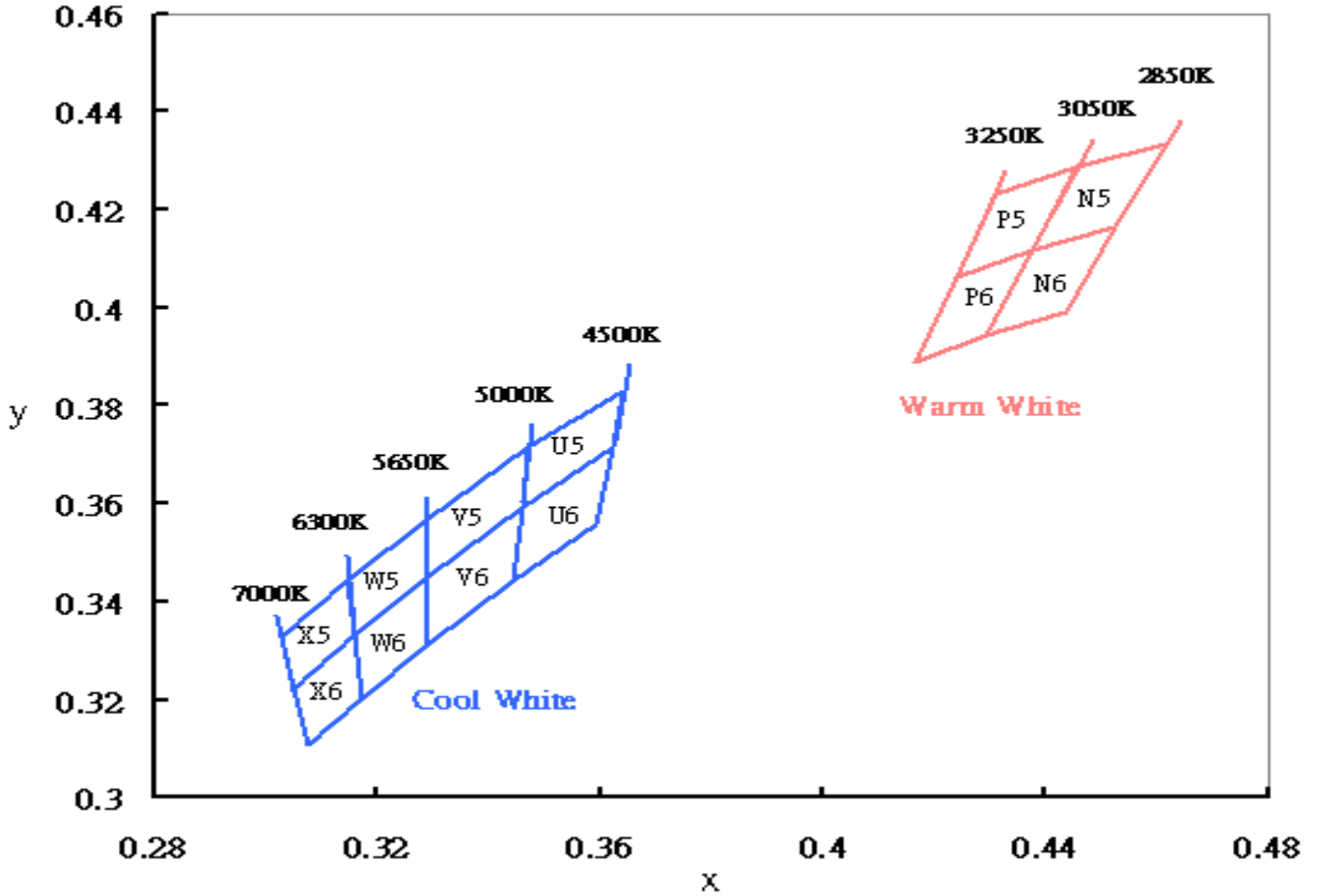

Technical Data Sheet

Top View LEDs

GT3020/X2C-BXXXXXXXXXX/2T

Typical Electro-Optical Characteristics Curves

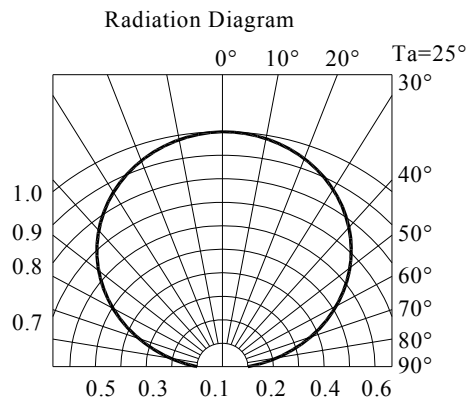
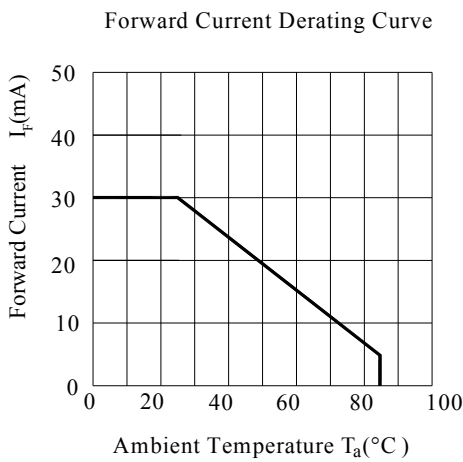
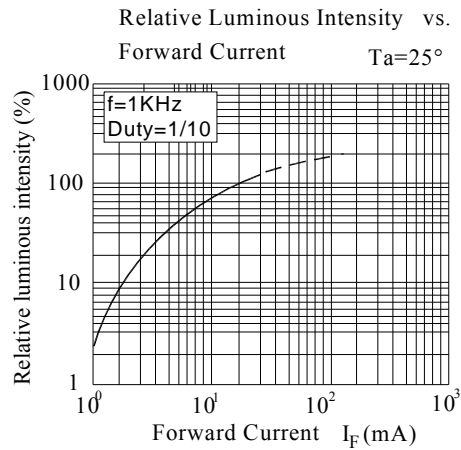
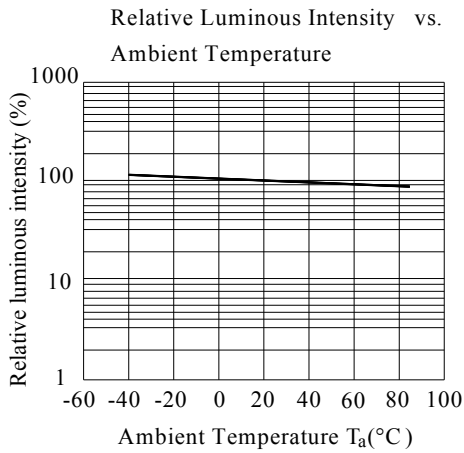
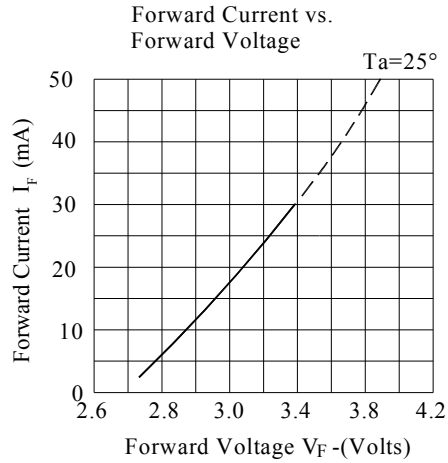
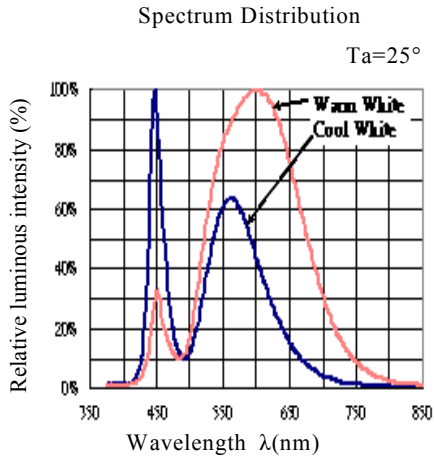

Technical Data Sheet

Top View LEDs

GT3020/X2C-BXXXXXXXXXX/2T

Label Explanation

CAT: Luminous Intensity Rank

HUE: Chromaticity Coordinates

REF: Forward Voltage Rank

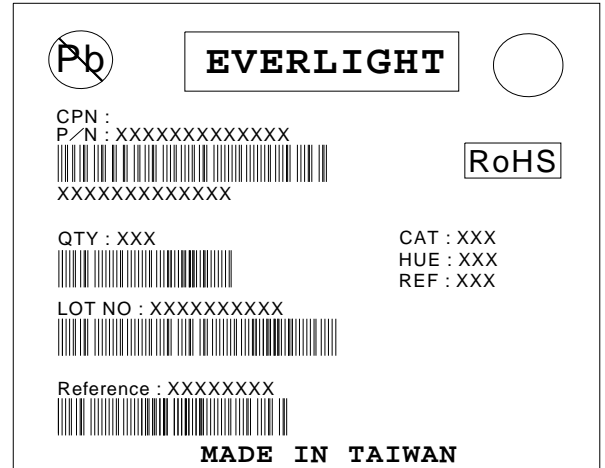

Reel Dimensions

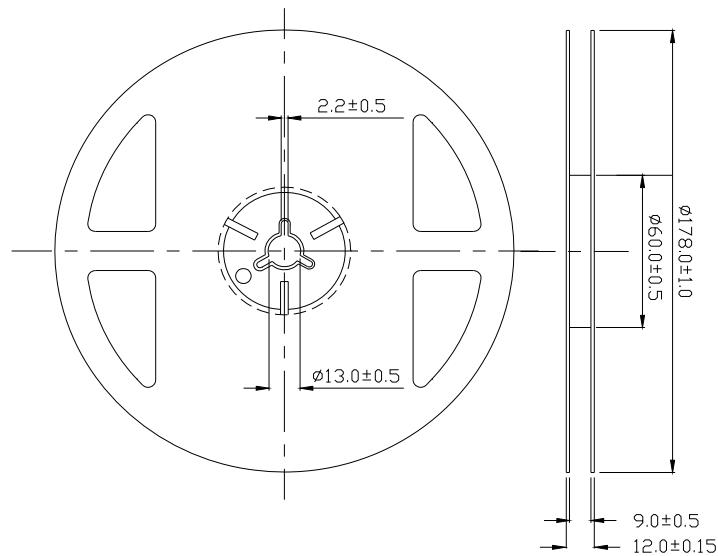

Note: Tolerance unless mentioned is ±0.1mm; Unit = mm

Technical Data Sheet

Top View LEDs

GT3020/X2C-BXXXXXXXXXX/2T

Carrier Tape Dimensions: Loaded Quantity 2000 pcs Per Reel.

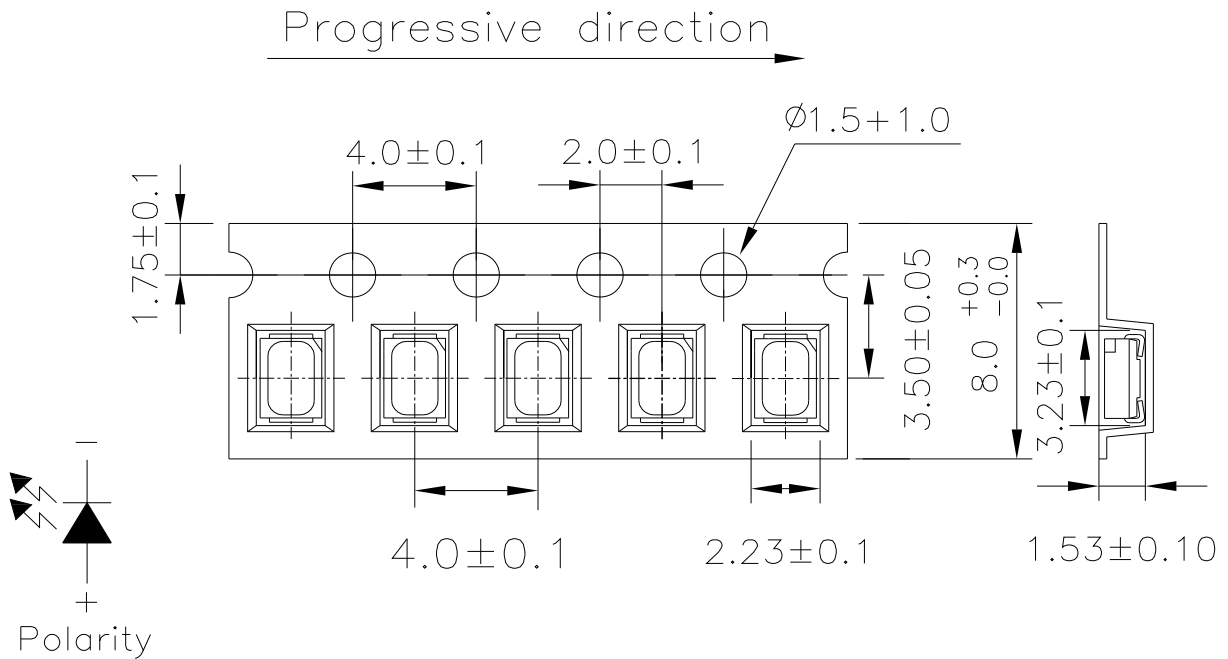

Note: Tolerance unless mentioned is ± 0.1 mm; Unit = mm

Moisture Resistant Packaging

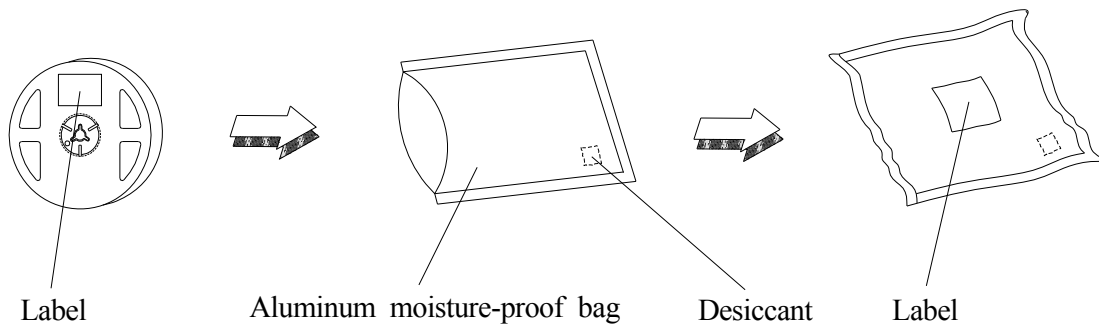

Technical Data Sheet**Top View LEDs****GT3020/X2C-BXXXXXXXXXX/2T****Reliability Test Items and Conditions**

The reliability of products shall be satisfied with items listed below.

Confidence level : 90%

LTPD : 10%

No.	Items	Test Condition	Test Hours/Cycles	Sample Size	Ac/Re
1	Reflow Soldering	Temp. : 260°C±5°C Min. 5sec.	6 Min.	22 PCS.	0/1
2	Temperature Cycle	H : +100°C 15min ∫ 5 min L : -40°C 15min	300 Cycles	22 PCS.	0/1
3	Thermal Shock	H : +100°C 5min ∫ 10 sec L : -10°C 5min	300 Cycles	22 PCS.	0/1
4	High Temperature Storage	Temp. : 100°C	1000 Hrs.	22 PCS.	0/1
5	Low Temperature Storage	Temp. : -40°C	1000 Hrs.	22 PCS.	0/1
6	DC Operating Life	I _F = 20 mA	1000 Hrs.	22 PCS.	0/1
7	High Temperature / High Humidity	85°C / 85%RH	1000 Hrs.	22 PCS.	0/1

Technical Data Sheet

Top View LEDs

GT3020/X2C-BXXXXXXXXXX/2T

Precautions for Use

1. Over-current-proof

Customer must apply resistors for protection; otherwise slight voltage shift will cause big current change (Burn out will happen).

2. Storage

2.1 Do not open moisture proof bag before the products are ready to use.

2.2 Before opening the package: The LEDs should be kept at 30°C or less and 90%RH or less.

2.3 After opening the package: The LED's floor life are 168 hours under 30°C or less and 60% RH or less. If unused LEDs remain, it should be stored in moisture proof packages.

2.4 If the moisture absorbent material (silica gel) has faded away or the LEDs have exceeded the storage time, baking treatment should be performed using the following conditions.

Baking treatment: 60±5°C for 24 hours.

3. Soldering Condition

3.1 Pb-free solder temperature profile

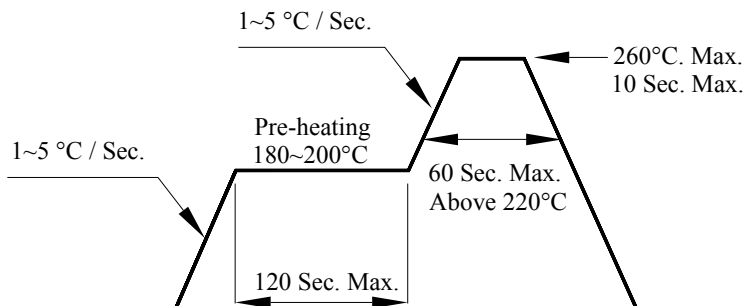

3.2 Reflow soldering should not be done more than two times.

3.3 When soldering, do not put stress on the LEDs during heating.

3.4 After soldering, do not warp the circuit board.

Technical Data Sheet

Top View LEDs

GT3020/X2C-BXXXXXXXXXX/2T

4. Soldering Iron

Each terminal is to go to the tip of soldering iron temperature less than 350°C for 3 seconds within once in less than the soldering iron capacity 25W. Leave two seconds and more intervals, and do soldering of each terminal. Be careful because the damage of the product is often started at the time of the hand solder.

5. Repairing

Repair should not be done after the LEDs have been soldered. When repairing is unavoidable, a double-head soldering iron should be used (as below figure). It should be confirmed beforehand whether the characteristics of the LEDs will or will not be damaged by repairing.

